

TPC-1571H TPC-1571HCA

15" XGA TFT LED LCD Intel® Atom™
Dual-Core D525 Touch Panel Computer

NEW

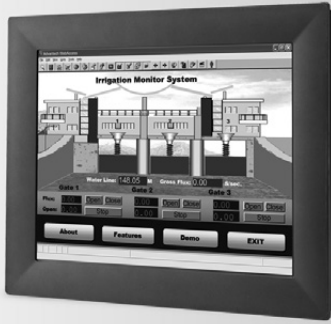

Features

- Intel® Atom™ D525 1.8 GHz processor
- 15" XGA TFT LED LCD
- Compact design with die-cast Al alloy front bezel
- Fanless cooling system
- IP65 approved front panel
- PCIe and Mini PCIe expansion support
- Supports 4 GB DDR3 SDRAM
- Integrated 16-channel Digital I/O with isolation
- 1 MB Battery-backed SRAM
- Serial port isolation protection
- Supports Microsoft® WES7/XP/WES/WinCE
- Supports external antenna for wireless communication
- Supports field-bus communication for PLC connectivity

Introduction

The TPC-1571H features a fanless low power consuming Intel® Atom™ Dual Core 1.8GHz processor 4GB DDR3 SDRAM and Resistive touch screen, and multiple I/O ports 2 x RS-232 with isolation, 1 x RS-422/485 with isolation. For data storage the fanless TPC devices also include: 1 x Compact Flash Slot and 1 x 2.5" SATA HDD. To expand function, this model provides PCIe and mini-PCIe expansion slots, an integrated 16-channel Digital I/O with isolation and 1MB Battery-backed SRAM.

The TPC-1571HCA comes complete with a CANopen card already installed. This CIA certified control ready platform assures total interoperability between all CANopen devices. The value added control ready platforms have total support for IEC-61131-3 Softlogic Control software as well as HMI/SCADA software and Advantech WebOP design and WebAccess control and monitoring software.

Specifications

General

- **BIOS** AMI 8Mbit
- **Certification** BSMI, CCC, CE, FCC Class A, UL
- **Cooling System** Fanless design
- **Dimensions (W x H x D)** 383 x 307 x 78.5 mm (15.08" x 12.09" x 3.09")
- **Enclosure** Front bezel: Die-cast Aluminum alloy
Back housing: PC/ABS Resin
- **Mounting** Desktop, Wall or Panel Mount
- **OS Support** Microsoft® Windows 7/WES7/WES 2009/XPE/CE 6.0/
Linux / Android
- **Power Consumption** 21 W (typical)
- **Power Input** 10~29 V_{DC}
- **Watchdog Timer** 1 ~ 255 sec (system)
- **Weight (Net)** 5.5 kg (12.13 lbs)

System Hardware

- **CPU** Intel® Atom™ D525 1.8 GHz with 1MB cache
- **Chipset** ICH8M
- **Memory** 4GB SO-DIMM DDR3 SDRAM
- **LAN** 10/100/1000Base-T x 2
- **Expansion Slots** Half-size PCI-E or full-size Mini PCI-E
- **Storage** CompactFlash® slot x 1
2.5" SATA HDD x 1 (Optional)
- **I/O** RS-232 x 2 (COM1, 2) with isolation
RS-422/485 x 1 (COM3) with isolation and auto data flow control
USB 2.0 x 2 (Host)
PS/2 x 1
- **DI/DO & backup SRAM** 8 x DI/DO with isolation and backup 1MB SRAM

LCD Display

- **Display Type** XGA TFT LED LCD
- **Display Size** 15"
- **Max. Resolution** 1024 x 768
- **Max. Colors** 262 K
- **Luminance cd/m²** 350
- **Viewing Angle (H/V°)** 160/140
- **Backlight Life** 50,000 hrs
- **Contrast Ratio** 700:1

Touchscreen

- **Lifespan** 36 million touches at single point
- **Light Transmission** Above 75%
- **Resolution** Linearity
- **Type** 5-wire, analog resistive

Environment

- **Humidity** 10 ~ 95% RH @ 40°C, non-condensing
- **Ingress Protection** Front panel: IP65
- **Operating Temperature** 0 ~ 50°C (32 ~ 122°F)
- **Storage Temperature** -20 ~ 60°C (-4 ~ 140°F)
- **Vibration Protection** With HDD: 1 Grms (5 ~ 500 Hz)
(Operating, random vibration)

Dimensions

Unit: mm

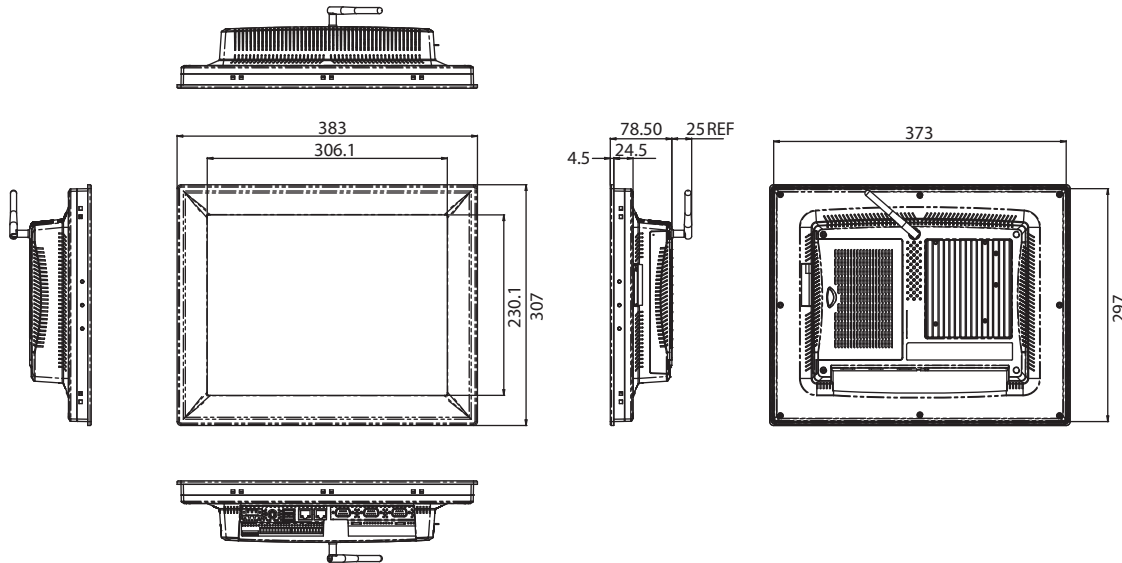

Panel Cut-out Dimensions: 374.5 x 298.5 mm (14.98" x 11.94")

CANopen (TPC-1571HCA only)

- **Controller** NXP SJA1000
- **Connector** DB9 x 2
- **Transceiver** NXP 82C251
- **Protocol** CAN2.0 A/B
- **Speed** 1Mbps
- **Signal Support** CAN_H, CAN_L, GND
- **Interrupt Support** Legacy INT, MSI

Ordering Information

- **TPC-1571H-D3AE** 15" XGA Touch Panel PC, D525 1.8 GHz, 4GB
- **TPC-1571HCA-D3AE** TPC-1571H-D3AE with PCM-2680 CANopen Card

Accessories

- **TPC-1000H-WMKE** TPC series wallmount kit from 10" to 17"
- **TPC-1000H-SMKE** TPC series stand kit from 10" to 17"
- **1757003463** 100-240V_{ac} to 19V_{dc} 90W Power Adapter
- **1700001524** Power Cord 3P UL 10A 125V 1.8M
- **1702002605** Power cable EU Plug 1.8M
- **1702031801** Power cable UK Plug 1.8M
- **1702031836** Power cable China/Australia Plug 1.8M
- **EWM-W139F01E** 802.11 b/g/n, RT5390, 1T1R, Full-size Mini-PCIe
- **PWR-247-AE** 50W DC 24V/2.3A Output Power Supply
- **1750000318** EMI Antenna 2DBI 2.4GHz SMA CONN for ARK-3384
- **1750003222** 802.11b/g 5dBi Dipole Antenna
- **1750003418** Wireless Antenna AN2400-5901RS R/P SMA.M9dB

* VESA support via a wall mounting kit

Rear View

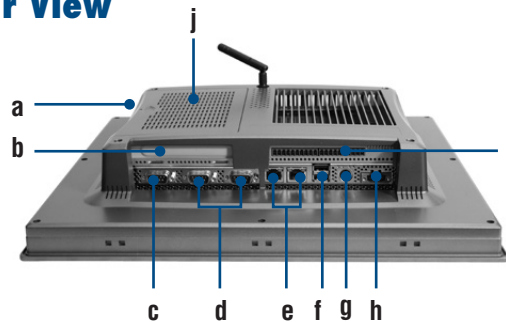

- a. CompactFlash
- b. PCI-E slot
- c. COM (RS-422/485)
- d. COM (RS-232)
- e. LAN (10/100/1000)
- f. USB 2.0
- g. PS/2
- h. Power Receptor
- i. DI/O ports
- j. Mini PCI-E slot

* Windows XPe supports 10 languages with MUL. (English, Traditional Chinese, Simplified Chinese, French, German, Spanish, Russian, Italian, Japanese and Korean)